

FLUKE®

165X

Electrical Installation Tester

Users Manual

September 2003

© 2003 Fluke Corporation, All rights reserved. Printed in USA
All product names are trademarks of their respective companies.

LIMITED WARRANTY AND LIMITATION OF LIABILITY

Each Fluke product is warranted to be free from defects in material and workmanship under normal use and service. The warranty period is three years and begins on the date of shipment. Parts, product repairs, and services are warranted for 90 days. This warranty extends only to the original buyer or end-user customer of a Fluke authorized reseller, and does not apply to fuses, disposable batteries, or to any product which, in Fluke's opinion, has been misused, altered, neglected, contaminated, or damaged by accident or abnormal conditions of operation or handling. Fluke warrants that software will operate substantially in accordance with its functional specifications for 90 days and that it has been properly recorded on non-defective media. Fluke does not warrant that software will be error free or operate without interruption.

Fluke authorized resellers shall extend this warranty on new and unused products to end-user customers only but have no authority to extend a greater or different warranty on behalf of Fluke. Warranty support is available only if product is purchased through a Fluke authorized sales outlet or Buyer has paid the applicable international price. Fluke reserves the right to invoice Buyer for importation costs of repair/replacement parts when product purchased in one country is submitted for repair in another country.

Fluke's warranty obligation is limited, at Fluke's option, to refund of the purchase price, free of charge repair, or replacement of a defective product which is returned to a Fluke authorized service center within the warranty period.

To obtain warranty service, contact your nearest Fluke authorized service center to obtain return authorization information, then send the product to that service center, with a description of the difficulty, postage and insurance prepaid (FOB Destination). Fluke assumes no risk for damage in transit. Following warranty repair, the product will be returned to Buyer, transportation prepaid (FOB Destination). If Fluke determines that failure was caused by neglect, misuse, contamination, alteration, accident, or abnormal condition of operation or handling, including overvoltage failures caused by use outside the product's specified rating, or normal wear and tear of mechanical components, Fluke will provide an estimate of repair costs and obtain authorization before commencing the work. Following repair, the product will be returned to the Buyer transportation prepaid and the Buyer will be billed for the repair and return transportation charges (FOB Shipping Point).

THIS WARRANTY IS BUYER'S SOLE AND EXCLUSIVE REMEDY AND IS IN LIEU OF ALL OTHER WARRANTIES, EXPRESS OR IMPLIED, INCLUDING BUT NOT LIMITED TO ANY IMPLIED WARRANTY OF MERCHANTABILITY OR FITNESS FOR A PARTICULAR PURPOSE. FLUKE SHALL NOT BE LIABLE FOR ANY SPECIAL, INDIRECT, INCIDENTAL OR CONSEQUENTIAL DAMAGES OR LOSSES, INCLUDING LOSS OF DATA, ARISING FROM ANY CAUSE OR THEORY.

Since some countries or states do not allow limitation of the term of an implied warranty, or exclusion or limitation of incidental or consequential damages, the limitations and exclusions of this warranty may not apply to every buyer. If any provision of this Warranty is held invalid or unenforceable by a court or other decision-maker of competent jurisdiction, such holding will not affect the validity or enforceability of any other provision.

Fluke Corporation
P.O. Box 9090
Everett, WA 98206-9090
U.S.A.

Fluke Europe B.V.
P.O. Box 1186
5602 BD Eindhoven
The Netherlands

Table of Contents

Title	Page
Introduction	1
Contacting Fluke	1
Unpacking the Tester.....	2
Operating the Tester.....	6
Using the Rotary Switch.....	6
Understanding the Pushbuttons.....	7
Understanding the Display	9
Input Terminals	16
Using the IR Port (Model 1653 Only)	16
Error Codes.....	17
Power-On Options	18
Making Measurements	20
Measuring Volts and Frequency	20
Measuring Insulation Resistance	21
Measuring Continuity	22
Measuring Loop/Line Impedance.....	24
Loop Impedance	24

Earth Resistance Testing by Loop Method	25
Line Impedance	26
Measuring RCD Tripping Time	28
Measuring RCD Tripping Current (Models 1652 and 1653 Only)	32
Measuring Earth Resistance (Model 1653 Only)	34
Testing Phase Sequence (Model 1653 Only)	35
Storing and Recalling Measurements (Model 1653 Only)	36
Using Memory Mode	36
Storing a Measurement	37
Recalling a Measurement	38
Clearing Memory	38
Uploading Test Results (Model 1653 Only)	39
Maintaining the Tester	40
Cleaning	40
Testing and Replacing the Batteries	41
Testing and Replacing the Fuse	42
Specifications	44
Features by Model	44
General Specifications	45
Electrical Measurement Specifications	47
AC Voltage Measurement (V)	47
Continuity Testing (R_{LO})	47
Insulation Resistance Measurement (R_{ISO})	48
Loop and Line Impedance (Z_I)	49
PFC, PSC Test	50
RCD Testing	51
RCD Types Tested	51
Test Signals	52

Tripping Speed Test (ΔT)	52
Tripping Speed Test (ΔT)	53
Tripping Current Measurement/Ramp Test ($I_{\Delta N}$)	54
Earth Resistance Test (R_E)	54
Phase Sequence Indication	55
Mains Wiring Test	55

List of Tables

Table	Title	Page
1.	Standard Accessories	2
2.	Country Specific Mains Cords.....	5

List of Figures







Figure	Title	Page
1.	Rotary Switch.....	6
2.	Pushbuttons	7
3.	Display Features	9
4.	Input Terminals	16
5.	Error Display	17
6.	Lead Swapping Modes	19
7.	Volts Display/Switch and Terminal Settings.....	20
8.	Insulation Resistance Display/Switch and Terminal Settings.....	21
9.	Continuity and Continuity Zero Display/Switch and Terminal Settings.....	22
10.	Loop/Line Impedance/Switch and Terminal Settings	24
11.	Display After Zeroing	25
12.	3-Wire Connection for Earth Resistance Loop Test.....	25
13.	Line Impedance Display.....	26
14.	Measuring in a 3-Phase System	27
15.	RCD Tripping Time Display/Switch and Terminal Settings	28
16.	RCD Tripping Current/Switch and Terminal Settings.....	32
17.	Connection for RCD Testing on IT Electrical Systems.....	33
18.	Earth Resistance Display/Switch and Terminal Settings.....	34

19.	Earth Resistance Test Connection	34
20.	Phase Sequence Display/Switch and Terminal Settings	35
21.	Phase Sequence Test Connection	35
22.	Attaching the IR Adapter	39
23.	Replacing the Fuse and Batteries	43

⚠ ⚠ Warnings: Read Before Using

To avoid possible electric shock or personal injury:

- Use the tester only as specified in this manual, or the protection provided by the tester might be impaired.
- Do not use the tester in wet environments.
- Inspect the tester before using it. Do not use the tester if it appears damaged. Look for cracks or missing plastic. Pay particular attention to the insulation around the connectors.
- Inspect the test leads before use. Do not use them if insulation is damaged or metal is exposed. Check the test leads for continuity. Replace damaged test leads before using the tester. Use only test leads specified in the manual or safety may be impaired.
- Verify the tester's operation by measuring a known voltage before and after using it. Do not use the tester if it operates abnormally. Protection may be impaired. If in doubt, have the tester serviced.
- Have the tester serviced only by qualified service personnel.
- Do not apply more than the rated voltage, as marked on the tester, between the terminals or between any terminal and earth ground.
- Remove test leads from the tester before opening the tester case.
- Never operate the tester with the case open.
- Use caution when working with voltages above 30 V ac rms, 42 V ac peak, or 60 V dc. These voltages pose a shock hazard.
- Use only the replacement fuse specified in the users manual.
- Use the proper terminals, function, and range for your measurements.
- Do not operate the tester around explosive gas, vapor, or dust.
- When using probes, keep your fingers behind the finger guards.
- When making electrical connections, connect the common test lead before connecting the live test lead; when disconnecting, disconnect the live test lead before disconnecting the common test lead.
- Replace the battery as soon as the low battery indicator () appears to avoid false readings that can lead to electric shock and injury.
- When servicing the tester, use only specified replacement parts.
- Do not use the tester in distribution systems with voltages higher than 550 V.
- When working on high energy systems, rubber gloves and flame-resistant face shield and clothing should be worn.

Definition of Symbols Used			
	Fuse		Caution! Risk of Electric Shock.
	Double Insulated (Class II) Equipment		Earth Ground
	Caution! Risk of Danger. Refer to Manual.		Conforms to relevant European standard.
CAT III	CAT III meters are designed to protect against transients in fixed-equipment installations at the distribution level.		

Electrical Installation Tester

Introduction

The Fluke Model 1651, Model 1652, and Model 1653 are battery powered electrical installation testers. This manual applies to all three models. All figures show the Model 1653.

The 165X testers are designed to measure and test the following:

- Voltage and Frequency
- Residual Current Devices (RCD) Tripping Time (EN61557-6)
- Insulation Resistance (EN61557-2)
- RCD Tripping Current (EN61557-6)
- Continuity (EN61557-4)
- Earth Resistance (EN61557-5)
- Loop/Line Resistance (EN61557-3)
- Phase Sequence (EN61557-7)

Contacting Fluke

To contact Fluke, call one of the following telephone numbers:

USA: 1-888-99-FLUKE (1-888-993-5853)

Canada: 1-800-36-FLUKE (1-800-363-5853)

Europe: +31 402-675-200

Japan: +81-3-3434-0181

Singapore: +65-738-5655

Anywhere in the world: +1-425-446-5500

Or, visit Fluke's Web site at www.fluke.com.

To register your product, visit register.fluke.com.

Unpacking the Tester

The tester comes with the items listed in Table 1. If the tester is damaged or an item is missing, contact the place of purchase immediately.

Table 1. Standard Accessories

Description	Model					Part Number
	1651	1652	1653	Robin 1652	Robin 1653	
165X-8008 Probe, Multifunctional	√	√	√			2000757
Country Specific Mains Test Cord	√	√	√	√	√	Various – See Table 2
TL-L1, Test Lead, Red		√	√			2044945
TL-L2, Test Lead Green	√	√	√			2044950
TL-L3, Test Lead Blue	√	√	√			2044961
Probe, Test, Banana Jack, 4 mm Tip, Red			√			803459
Probe, Test, Banana Jack, 4 mm Tip, Green	√	√	√			2065297

Table 1. Standard Accessories (cont.)

Description	Model					Part Number
	1651	1652	1653	Robin 1652	Robin 1653	
Probe, Test, Banana Jack, 4 mm Tip, Blue	√	√	√			2068904
102-406-003, Probe cap,GS-38 Red	√	√	√	√	√	1942029
102-406-002, Probe cap,GS-38 Green	√	√	√			2065304
102-406-004, Probe cap,GS-38 Blue	√	√	√			2068919
AC285-5001,175-276-013 AC285 Large crocodile clip, Red		√	√			2041727
AC285-5001-02,175-276-012 AC285 Large crocodile clip, Green	√	√	√			2068133

Table 1. Standard Accessories (cont.)

Description	Model					Part Number
	1651	1652	1653	Robin 1652	Robin 1653	
AC285-5001-03,175-276-0114 AC285 Large crocodile clip, Blue	√	√	√			2068265
Test lead set, 600 V, Fused Probe - ST plug with crocodile clips, Red, Blue, Green Replacement fuse is a F 10 A 600 V, 50 kA fuse meeting the IEC60269-1 standard.				√	√	2068742
CD ROM, Users Manual	√	√	√	√	√	1674214
Quick Reference Card	√	√	√	√	√	1674804
Case, Tool Box, Yellow	√	√	√	√	√	1664213
Hard Case Insert, Foam, Polyurethane	√	√	√	√	√	2061011
Carrying Strap, Padded	√	√	√	√	√	2045406
Fluke-1653-2014, IR Adapter			√		√	2043365

Table 2. Country Specific Mains Cords

Mains Cord	Cord Type	Part Number
British	BS1363	2061367
Shuko Germany/France/Belgium	CEE 7/7	2061332
Denmark	AFSNIT 107-2-DI	2061371
Australia/New Zealand	AS 3112	2061380
Switzerland	SEV 1011	2061359
Italy	CEI 23-16/VII	2061344

Operating the Tester

Using the Rotary Switch

Use the rotary switch (Figure 1) to select the type of test you want to perform.

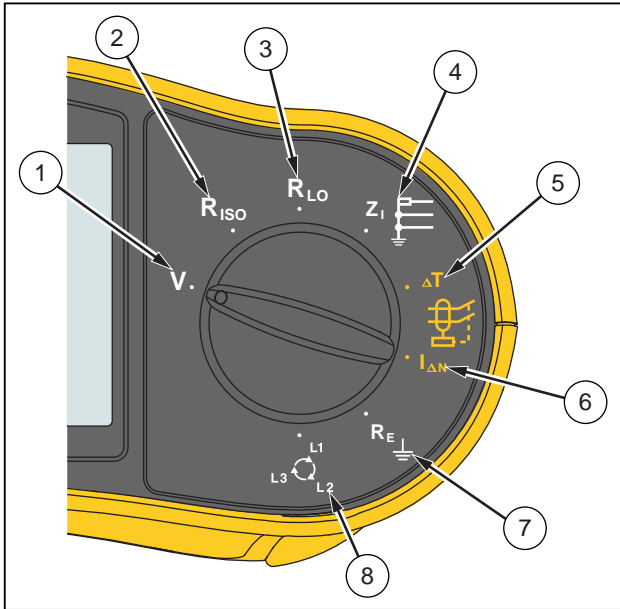

apx013f.eps

Figure 1. Rotary Switch

Number	Symbol	Measurement Function
①	V	Volts.
②	R_{ISO}	Insulation resistance.
③	R_{LO}	Continuity.
④	Z_l	Loop impedance.
⑤	ΔT	RCD tripping time.
⑥	$I_{\Delta N}$	RCD tripping level.
⑦	R_E	Earth resistance.
⑧	↻	Phase rotation.

Understanding the Pushbuttons

Use the pushbuttons (Figure 2) to control operation of the tester, select test results for viewing, and scroll through selected test results.

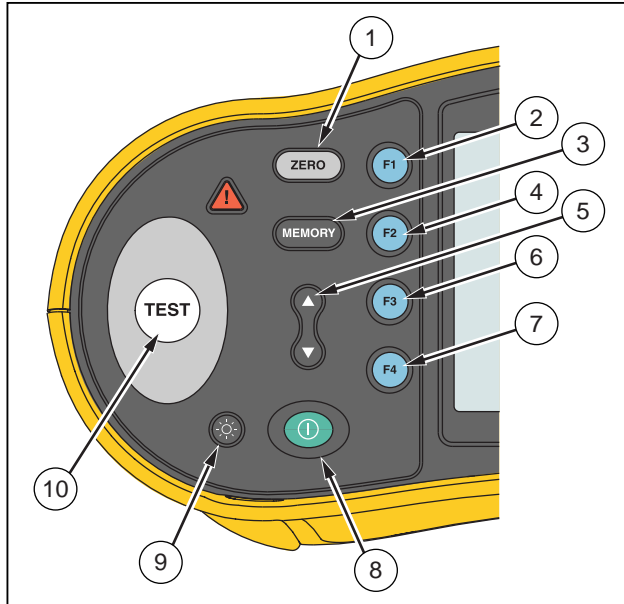



apx012f.eps

Figure 2. Pushbuttons

No.	Button	Description
①	ZERO	Zero test lead resistance offset.
②	F1	<ul style="list-style-type: none"> Loop input select (L-N, L-PE). RCD current rating (10, 30, 100, 300, 500, or 1000 mA). Memory SELECT.
③	MEMORY	<ul style="list-style-type: none"> Enters Memory mode. Activates memory soft key selections (F1, F2, F3, or F4).
④	F2	<ul style="list-style-type: none"> RCD Current multiplier (x1/2, x1, x5, AUTO). Memory STORE.
⑤	▲▼	<ul style="list-style-type: none"> Scroll memory locations. Set memory location codes. Scroll Auto test results.

No.	Button	Description
⑥	F3	<ul style="list-style-type: none"> RCD type (AC, DC, AC-S, or DC-S). Memory RECALL.
⑦	F4	<ul style="list-style-type: none"> RCD test polarity (0, 180 degrees). Insulation test voltage (50, 100, 250, 500, or 1000 V). Memory CLEAR.
⑧	ⓘ	Turns the tester on and off. The tester will also shut off automatically if there is no activity for 10 minutes.
⑨	☉	Turns the backlight on and off.



No.	Button	Description
⑩	TEST	<p>Starts the selected test.</p> <p>The  key is surrounded by a “touch pad”. The touch pad measures the potential between the operator and the tester’s PE terminal. If you exceed a 100 V threshold, the  symbol above the touch pad is illuminated.</p>

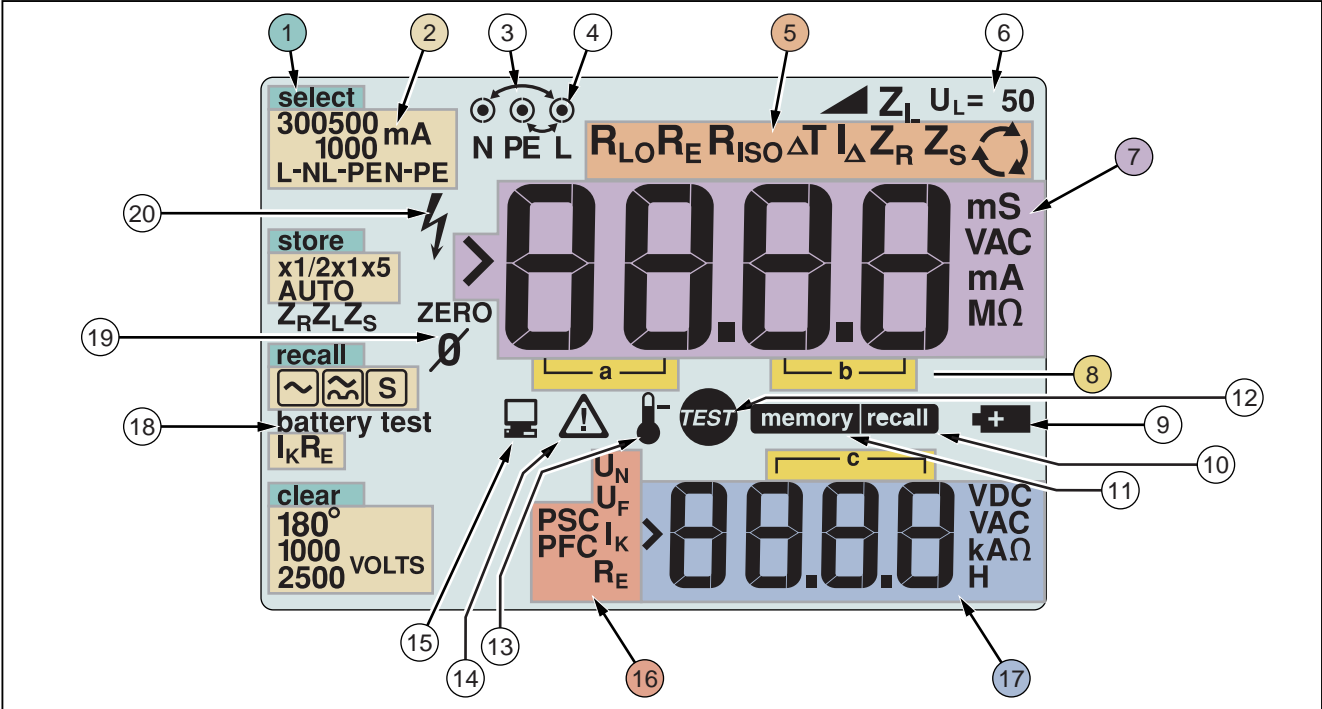

Understanding the Display









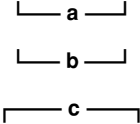

apx020f.eps

Figure 3. Display Features



No.	Annunciator	Meaning
①	select store recall clear	Displays the selected Memory mode. Memory modes are: Select (F1), Store (F2), Recall (F3), or Clear (F4).
②	300500 mA 1000 L-NL-PEN-PE x1/2x1x5 AUTO  I_{KR_E} 180° 1000 2500 VOLTS	Configuration options. Settings you can make within the measurement functions. For example, in the RCD Tripping Time function (ΔT) you can press (F2) to multiply the test current by x1/2, x1, x5 or AUTO and you can press (F3) to select the type of RCD you are testing.
③		Arrows above or below the terminal indicator symbol indicate reversed polarity. Check the connection or check the wiring to correct.
④		Terminal indicator symbol. A terminal indicator symbol with a dot (⊙) in the center indicates the terminal is used for the selected function. The terminals are: <ul style="list-style-type: none"> • L (Line) • PE (Protective Earth) • N (Neutral)

No.	Annunciator	Meaning
⑤	$R_{LO} R_E R_{ISO} A^T I_{\Delta}$ 	<p>Indicates the selected rotary switch setting. The measurement value in the primary display also corresponds to the switch setting. Rotary switch settings are:</p> <p>V Volts</p> <p>R_{ISO} Insulation</p> <p>R_{LO} Continuity</p> <p>Z_L Loop</p> <p>A^T RCD time</p> <p>I_Δ RCD trip</p> <p>R_E Earth</p> <p> Phase Rotation</p>
⑥	$U_L =$	<p>Indicates the preset fault voltage limit. The default setting is 50 V. Some locations require the fault voltage be set to 25 V, as specified by local electrical codes.</p> <p>Press  when you turn on the tester to toggle the fault voltage between 25 V and 50 V. The value you set will appear on the display and will be saved when you turn the tester off.</p>

No.	Annunciator	Meaning
⑦		Primary display and measurement units.
⑧		Memory locations. See “Storing and Recalling Measurements” on page 36 for detailed information on using memory locations.
⑨		Low battery icon. See “Testing and Replacing the Batteries” on page 41 for additional information on batteries and power management.
⑩		Appears when you press the Recall button and you are looking at stored data.
⑪		Appears when you press the Memory button.
⑫		Appears when you press the Test button. Disappears when the test is completed.
⑬		Appears when the instrument is overheated. The Loop test and RCD functions are inhibited when the instrument is overheated.
⑭		Appears when an error occurs. Testing is disabled. See “Error Codes” on page 17 for a listing and explanation of possible error codes.

No.	Annunciator	Meaning
⑮		Appears when the instrument is uploading data using FlukeView Forms.
⑯	$ \begin{array}{c} U_N \\ U_F \\ PSC \\ PFC \\ I_K \\ R_E \end{array} $	<p>Name of the secondary measurement function.</p> <p>U_N Test voltage for insulation test.</p> <p>U_F Fault voltage. Measures neutral to earth.</p> <p>PSC Prospective Short Circuit. Calculated from measured voltage and impedance when reading line to neutral.</p> <p>PFC Prospective Fault Current. Calculated from voltage and loop impedance which is measured line to protective earth.</p> <p>I_K Tripping current for RCDs.</p> <p>R_E Earth resistance.</p>

No.	Annunciator	Meaning
⑰		<p>Secondary display and measurement units. Some tests will return more than one result or return a computed value based on the test result. This will occur with:</p> <ul style="list-style-type: none"> • Volts Secondary display shows line frequency. • Insulation tests Secondary display shows actual test voltage. • Loop impedance Secondary display shows PSC, PFC, or R_E. • RCD switching time Secondary display shows U_F fault voltage. • RCD tripping current Secondary display shows U_F fault voltage.

No.	Annunciator	Meaning
⑱	battery test	Appears when you are testing the batteries. For more information see “Testing and Replacing the Batteries” on page 41.
⑲	ZERO	Appears when you press the  button to zero the leads. After the zeroing operation, the icon stays illuminated indicating that zeroing has been performed. Only used when performing continuity or loop testing.
⑳		Potential danger. Appears when measuring or sourcing high voltages.

Input Terminals

Figure 4 shows the 165X input terminals.

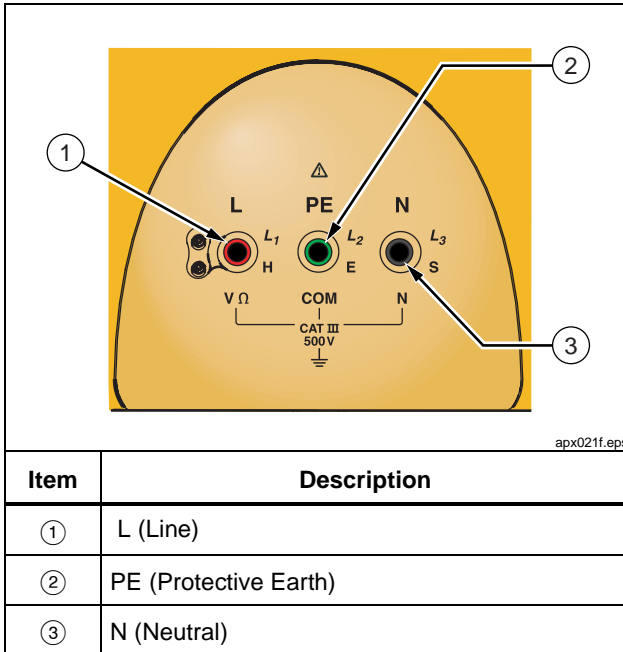

Figure 4. Input Terminals

Using the IR Port (Model 1653 Only)

The Model 1653 tester has an IR port (Figure 22) that allows you to connect the tester to a computer and upload test data using *Flukeview Forms Documenting Software*. This automates your troubleshooting or recording process, reduces the possibility of manual error and allows you to collect, organize, and display test data in a format that meets your needs. See “Uploading Test Results” on page 39 for additional information on using the IR port.

Error Codes

Various error conditions are detected by the tester and are indicated with the ⚠ icon, "Err", and an error number on the primary display. These error conditions disable testing and, if necessary, stop a running test.

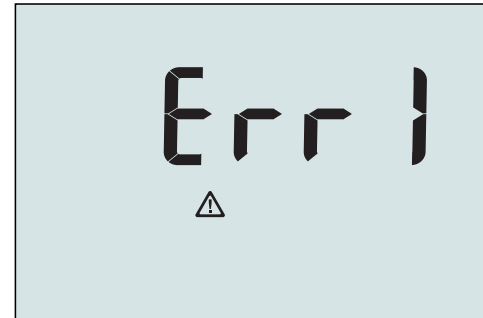

Error Condition	Code
Self-Test Fails	1
Over-Temp	2
Fault Voltage	4
Excessive Noise	5
Probe Resistance	6
<i>Note</i>	
<i>If the self-test fails, you will need to return the tester to Fluke for service.</i>	











apx032f.eps

Figure 5. Error Display

Power-On Options

To select a power-on option, press  and the function key simultaneously and then release the  button. Power-on options are retained when the tester is turned OFF.

Keys	Power-On Options
 	<p>Line and Neutral Swap mode. There are two possible modes of operation when the tester detects that the Line and Neutral leads are swapped. The  icon on the display indicates a swapped test lead.</p> <p>You can configure the tester to operate in L-n mode or L-n n-L mode.</p> <ul style="list-style-type: none"> In L-n n-L mode the tester corrects the condition by swapping internal connections and testing continues.

Keys	Power-On Options
  (cont.)	<ul style="list-style-type: none"> When a swapped lead is detected In L-n mode, testing is inhibited and you must manually swap the leads. L-n mode is intended for use in the UK. Selecting L-n mode also changes the x1/2 RCD trip time duration to 2 seconds as required in the UK. <p style="text-align: center;"><i>Note</i></p> <p><i>In locations where polarized plugs and outlets are used, a swapped lead icon () may indicate that the outlet was wired incorrectly. Correct this problem before proceeding with any testing.</i></p>
 	Fault voltage limit. Toggles the fault voltage between 25 V and 50 V. The default is 50 V.

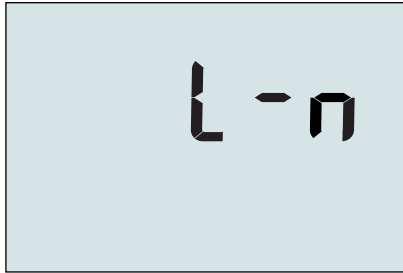

Manual Lead
Swapping
Mode Selected

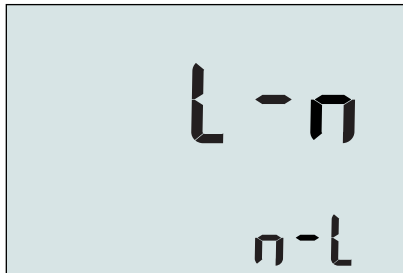

Automatic Lead
Swapping
Mode Selected

apx026f.eps

Figure 6. Lead Swapping Modes

Making Measurements

Measuring Volts and Frequency

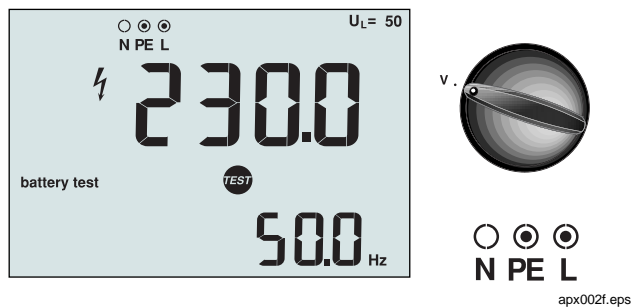

Figure 7. Volts Display/Switch and Terminal Settings

To measure voltage and frequency

1. Turn the rotary switch to the V position.
2. Use the L and PE (red and green) terminals for this test. You can use test leads or mains cord when measuring AC voltage.
 - The primary (upper) display shows the AC voltage. The tester reads AC voltage to 500 V.
 - The secondary (lower) display shows mains frequency.

Measuring Insulation Resistance

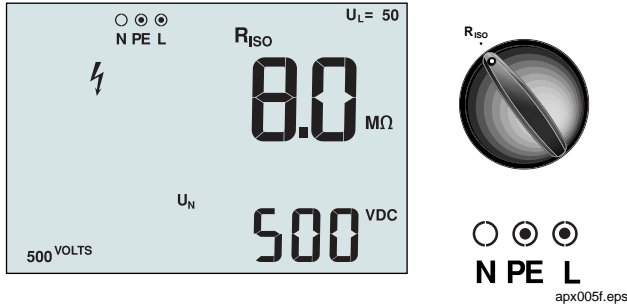

Figure 8. Insulation Resistance Display/Switch and Terminal Settings

⚠ ⚠ Warning

Measurements should only be performed on de-energized circuits.

To measure insulation resistance

1. Turn the rotary switch to the R_{ISO} position.
2. Use the L and PE (red and green) terminals for this test.

3. Use the (F4) to select the test voltage. Most insulation testing is performed at 500 V, but observe local test requirements.
4. Press and hold (TEST) until the reading settles and the tester beeps. For most tests you will want to use the probe with the remote control (TEST) button.

Note

Testing is inhibited if voltage is detected in the line.

- The primary (upper) display shows the insulation resistance.
- The secondary (lower) display shows the actual test voltage.

Note

For normal insulation with high resistance, the actual test voltage (U_N) should always be equal to or higher than the programmed voltage. If insulation resistance is bad, the test voltage is automatically reduced to limit the test current to safe ranges.

Measuring Continuity

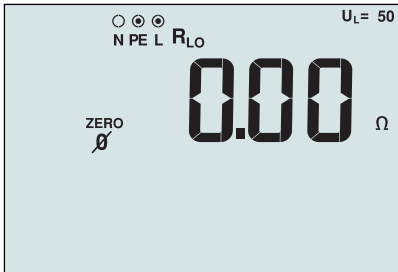
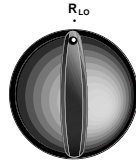
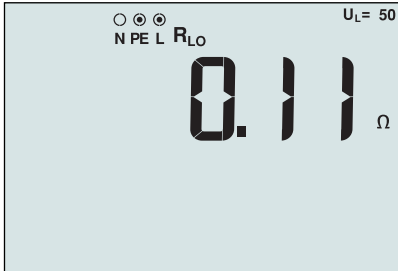

Figure 9. Continuity and Continuity Zero Display/Switch and Terminal Settings

apx003f.eps

A continuity test is used to verify the integrity of connections by making a high resolution resistance measurement. This is especially important for checking Protective Earth connections.

Note

In locales where electrical circuits are laid out in a ring, it is recommended that you make an end-to-end check of the ring at the electrical panel.

⚠ ⚠ Warning

- **Measurements should only be performed on de-energized circuits.**
- **Measurements may be adversely affected by impedances or parallel circuits or transient currents.**

To measure continuity

1. Turn the rotary switch to the R_{LO} position.
2. Use the L and PE (red and green) terminals for this test.

3. Before making a continuity test, short the ends of the probes together and press . The tester measures probe resistance, stores the reading in memory, and subtracts it from readings. The resistance value is saved even when power is turned off so you don't need to repeat the operation every time you use the instrument.

4. Press and hold  until the reading settles and the tester beeps. If a circuit is live, the test is inhibited and the AC voltage appears in the secondary (lower) display.

Measuring Loop/Line Impedance

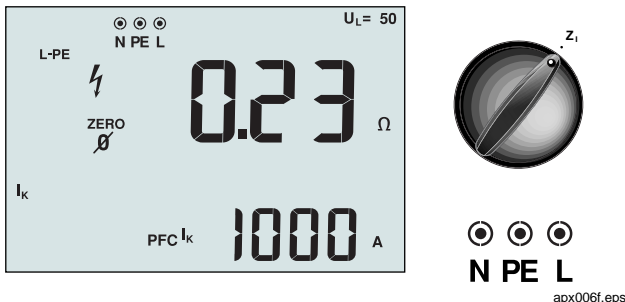

Figure 10. Loop/Line Impedance/Switch and Terminal Settings

Loop Impedance

Loop impedance is source impedance measured between Line and Protective Earth. You can also measure the Prospective Fault Current (PFC) which is the current that could potentially flow if the phase conductor is shorted to the protective earth conductor. The tester calculates the PFC by dividing the measured mains voltage by the loop impedance.

Note

If the L and N terminals are reversed, the tester will auto-swap them internally and continue testing. If the tester is configured for UK operation, testing will halt and you will need to manually swap the terminals. This condition is indicated by arrows above or below the terminal indicator symbol (⊕⊖).

To measure loop impedance

1. Turn the rotary switch to the Z_1 position.
2. Press (F1) to select L-PE.
3. Before measuring, zero the test probes by shorting all three leads together at the far end (away from the tester) and press the (ZERO) button. To zero the mains cord, wrap a piece of bare wire around the terminals of the plug and press the (ZERO) button. The tester saves the zero offset so you don't need to repeat the operation every time you use the tester.

⚠ ⚠ Warning

Remove the bare wire before proceeding with the test.

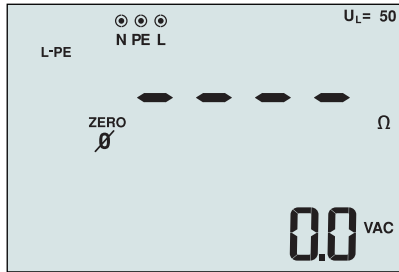

apx033f.eps

Figure 11. Display After Zeroing

4. Press and release TEST . Wait for the test to complete.
5. The primary (upper) display shows the loop impedance.
6. To read the Prospective Fault Current, press the F3 key and select I_K . The PFC appears in amps or kiloamps in the secondary (lower) display.

Note

Errors may occur due to preloading the circuit under test.

Earth Resistance Testing by Loop Method

You can also use the tester to measure the earth resistance component of the total loop resistance. Check your local regulations to determine if this method is acceptable in your area. You can use three leads or the mains cord to perform this test. Use the connection shown in Figure 12 when making a 3-wire connection for earth resistance loop test.

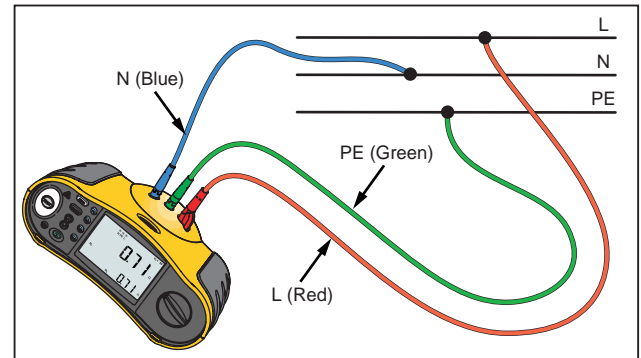

apx024f.eps

Figure 12. 3-Wire Connection for Earth Resistance Loop Test

To measure earth resistance using the loop test method

1. Turn the rotary switch to the Z_I position.
2. Press $(F1)$ to select L-PE.
3. Press $(F3)$ to select R_E (resistance).
4. Press and release $(TEST)$. Wait for the test to complete.
 - The primary (upper) display shows the loop impedance.
 - The secondary (lower) display shows the earth resistance.

Line Impedance

Line impedance is source impedance measured between Line and Neutral. You can use this to measure:

- Impedance Line to Neutral.
- Line to Line impedance in 3-phase systems.

- L-PE loop measurement. This is a way of making a high current, 2-wire loop measurement. It cannot be used on circuits protected by RCDs because it will cause them to trip.

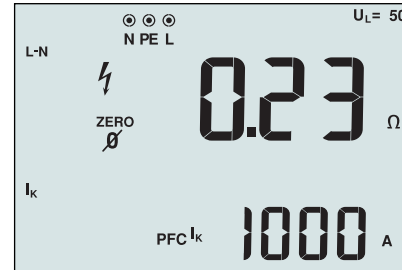

Figure 13. Line Impedance Display

apx034f.eps

To measure line impedance

1. Turn the rotary switch to the Z_I position.
2. Press $(F1)$ to select L-N.
3. You can use the mains cord or test leads for this measurement. With test leads use the red and blue leads connecting to L and N terminals on the tester.

4. Press and release . Wait for the test to complete.

- The primary (upper) display shows the line impedance.
- The secondary (lower) display shows the Prospective Short Circuit Current (PSC). PSC is the current that would flow in case of a Line to Neutral short. It is calculated by dividing mains voltage by line impedance.

Use the connection shown in Figure 14 when measuring in a 3-phase system.

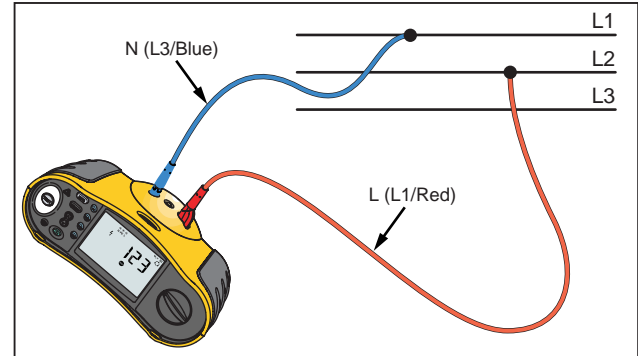

Figure 14. Measuring in a 3-Phase System

apx025f.eps

Measuring RCD Tripping Time

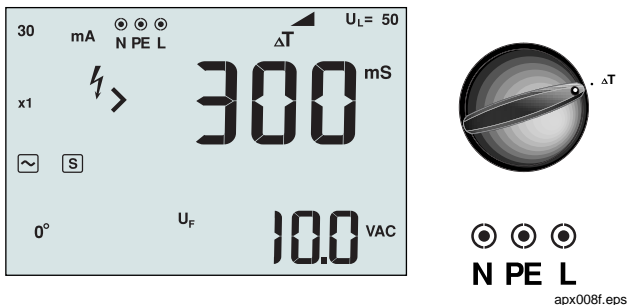

Figure 15. RCD Tripping Time Display/Switch and Terminal Settings

In this test, a calibrated fault current is induced into the circuit, causing the RCD to trip. The meter measures and displays the time required for the RCD to trip. You can perform this test with test leads or using the mains cord. The test is performed with a live circuit.

Note

When measuring trip time for any type RCD, the tester first does a pretest to determine if the actual test will cause a fault voltage exceeding the limit (25 or 50 V). To avoid having an inaccurate trip time for S type (time delay) RCDs, a 30 second delay is activated between the pretest and the actual test.

⚠ ⚠ Warning

- Test the connection between the N-conductor and earth before starting the test. A voltage between the N-conductor and earth may influence the test.
- Leakage currents in the circuit following the residual current protection device may influence measurements.
- The displayed fault voltage relates to the residual operating current of the RCD.
- Potential fields of other earthing installations may influence the measurement.

Note







If the L and N terminals are reversed, the tester will auto-swap them internally and continue testing. If the tester is configured for UK operation, testing will halt and you will need to manually swap the terminals. This condition is indicated by arrows above or below the terminal indicator symbol (ⓁⓃⓃ). See Power-On Options on page 18 for information on setting Line and Neutral Swap mode.

To measure RCD tripping time

1. Turn the rotary switch to the ΔT position.
2. Press F1 to select the RCD current rating (10, 30, 100, 300, 500, or 1000 mA).
3. Press F2 to select a test current multiplier (x 1/2, x 1, x 5, or Auto). Normally you will use x 1 for this test.

Note

Model 1651 only allows selection of the x1 multiplier.

4. Press F3 to select the RCD type. Valid types are:
 -  – Standard AC RCD, normal setting. (All models)
 -  – DC sensitive RCD. (Models 1652 and 1653 only)
 -   – Delayed response AC RCD. (All models)
 -   – Delayed response DC RCD. (Models 1652 and 1653 only)

5. Press **F4** to select the test current phase, 0° or 180°. RCDs should be tested with both phase setting, as their response time can vary significantly depending on the phase.
6. Press and release **TEST**. Wait for the test to complete.
 - The primary (upper) display shows the trip time.
 - The secondary (lower) display shows any fault voltage (N to PE).

You can also use the tester to perform the RCD tripping time test in Auto mode, which makes it easier for one person to perform the test.



To measure RCD tripping time using Auto mode

1. Plug the tester into the outlet.
 2. Turn the rotary switch to the ΔT position.
 3. Press **F1** to select the RCD current rating (10, 30, 100, 300, 500, or 1000 mA).
4. Press **F2** to select Auto mode.
 5. Press **F3** to select a standard AC RCD ()

The tester supplies ½x the rated RCD current for 310 or 510 ms (2 seconds in the UK). If the RCD trips, the test terminates. If the RCD does not trip, the tester reverses phase and repeats the test. The test terminates if the RCD Trips.

If the RCD does not trip, the tester restores the initial phase setting and supplies 1x the rated RCD current for 2000 ms. The RCD should trip and the test results appear in the primary display.
 6. Reset the RCD.
 7. The tester reverses phases and repeats the 1x test. The RCD should trip and the test results appear in the primary display.
 8. Reset the RCD.

9. The tester restores the initial phase setting and supplies 5x the rated RCD current for up to 50 ms. The RCD should trip and the test results appear in the primary display.
10. Reset the RCD.
11. The tester reverses phase and repeats the 5x test. The RCD should trip and the test results appear in the primary display.
12. Reset the RCD.

You can use the  arrow keys to review test results. The first result shown is the last measurement taken, the 5x current test. Press the down arrow key  to move backward to the first test at ½x the rated current.

13. Test results are in temporary memory. If you want to store the test results, press  and proceed as described in “Storing and Recalling Measurements” on page 36 of this manual. Measurement storage and recall is available only on Model 1653.

Measuring RCD Tripping Current (Models 1652 and 1653 Only)

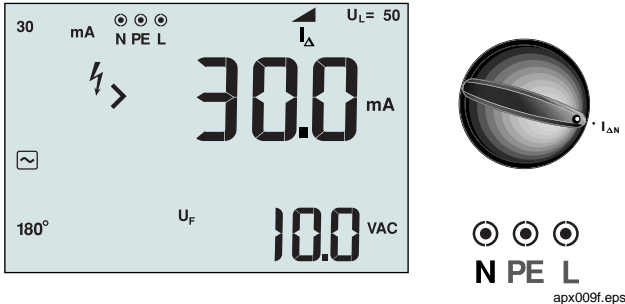

Figure 16. RCD Tripping Current/Switch and Terminal Settings

This test measures the RCD tripping current by applying a test current and then gradually increasing the current until the RCD trips. You can use the test leads or mains cord for this test. A 3-wire connection is required.





⚠ ⚠ Warning

- Test the connection between the N-conductor and earth before starting the test. A voltage between the N-conductor and earth may influence the test.
- Leakage currents in the circuit following the residual current protection device may influence measurements.
- The displayed fault voltage relates to the residual operating current of the RCD.
- Potential fields of other earthing installations may influence the measurement.

Note

If the L and N terminals are reversed, the tester will auto-swap them internally and continue testing. If the tester is configured for UK operation, testing will halt and you will need to manually swap the terminals. This condition is indicated by arrows above or below the terminal indicator symbol (⊕ ⊖). See Power-On Options on page 18 for information on setting Line and Neutral Swap mode.

To measure RCD tripping current

1. Turn the rotary switch to the $I_{\Delta N}$ position.
2. Press $(F1)$ to select the RCD current rating.
3. Press $(F3)$ to select the RCD type. Valid types are:
 -  – Standard AC RCD, normal setting. (All models)
 -  – DC sensitive RCD. (Models 1652 and 1653 only)
 -  (S) – Delayed response AC RCD. (All models)
 -  (S) – Delayed response DC RCD. (Models 1652 and 1653 only)
4. Press $(F4)$ to select the test current phase, 0° or 180° . RCDs should be tested with both phase setting, as their response time can vary significantly depending on the phase.
5. Press and release $(TEST)$. Wait for the test to complete.
 - The primary (upper) display shows the RCD trip current.

RCD testing at locations with IT systems requires a special test procedure because the Protective Earth connection is grounded locally and is not tied directly to the power system.

The test cannot be conducted at an outlet but can be done at the electrical panel using probes. Use the connection shown in Figure 17 when performing RCD testing on IT electrical systems.

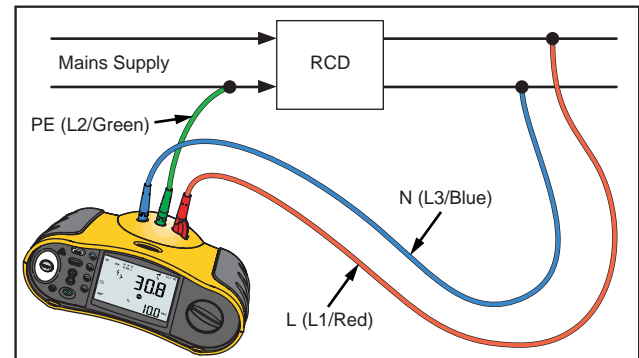

Figure 17. Connection for RCD Testing on IT Electrical Systems

The test current flows through the upper side of the RCD, into the L terminal, and returns through the PE terminal.

Measuring Earth Resistance (Model 1653 Only)

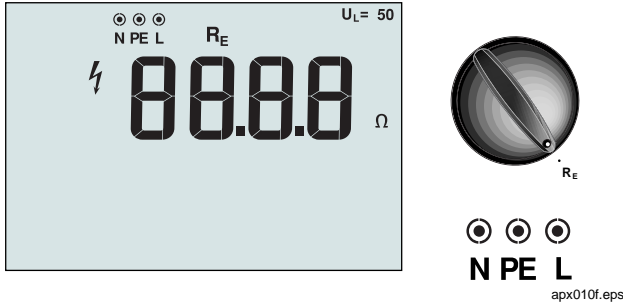

Figure 18. Earth Resistance Display/Switch and Terminal Settings

The earth resistance test is a 3-wire test consisting of two test stakes and the earth electrode under test. This test requires an accessory stake kit. Connect as shown in Figure 19.

- Best accuracy is achieved with the middle stake at 62% of the distance to the far stake. The stakes should be in a straight line and wires separated to avoid mutual coupling.
- The earth electrode under test should be disconnected from the electrical system when conducting the test. Earth resistance testing should not be performed on a live system.

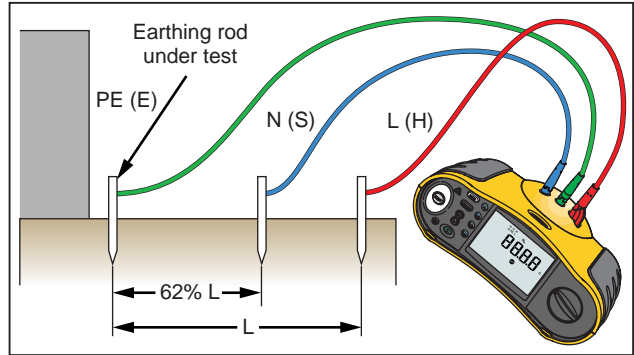



Figure 19. Earth Resistance Test Connection

To measure earth resistance

1. Turn the rotary switch to the R_E position.
2. Press and release . Wait for the test to complete.
 - The primary (upper) display shows the earth resistance reading.
 - Voltage detected between the test rods will be displayed in the secondary display. If greater than 10 V, the test is inhibited.

Testing Phase Sequence (Model 1653 Only)

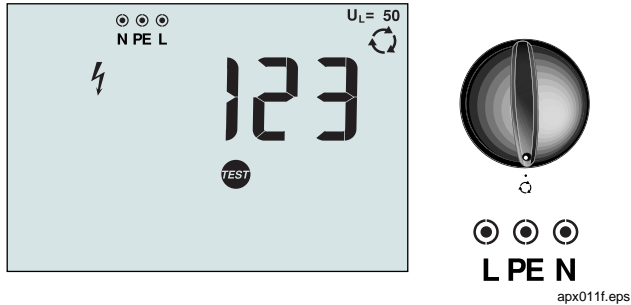

Figure 20. Phase Sequence Display/Switch and Terminal Settings

Use the connection shown in Figure 21 when making a phase sequence test connection.

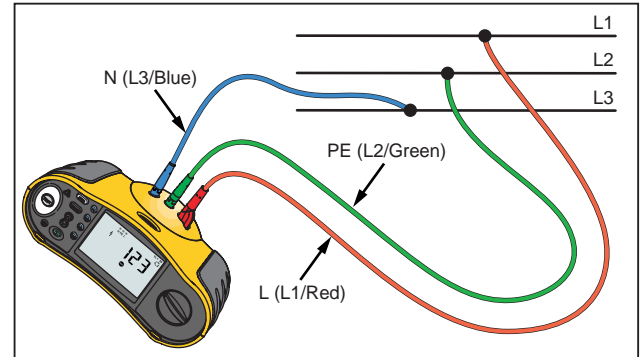



Figure 21. Phase Sequence Test Connection

To perform a phase sequence test

1. Turn the rotary switch to the  position.
2. The primary (upper) display shows:
 - 123 for correct phase sequence.
 - 321 for reversed phase sequence.
 - Dashes (---) instead of numbers if insufficient voltage is sensed.

Storing and Recalling Measurements (Model 1653 Only)

Using Memory Mode

You can store up to 500 measurements on the tester. The information stored for each measurement consists of the test function and all user selectable test conditions.

Data for each measurement is assigned a data set number, data subset number, and a data id number. Memory location fields are used as described below.

Field	Description
┌ a ─┐	Use the data set field (a) to indicate a location such as a room or electrical panel number.
┌ b ─┐	Use the data subset field (b) for circuit number.

Field	Description
┌ c ─┐	The data id number field (c) is the measurement number. The measurement number automatically increments. The measurement number can also be set to a previously used value to overwrite an existing measurement.

To enter Memory mode

1. Press the **MEMORY** button to enter Memory mode. The display changes to a memory mode display. In Memory mode, the **memory** icon appears on the display. The primary numeric display will be active with the left two digits (a) indicating the data set number (1-99) and the right two digits (b) indicating the data subset number. The decimal point separating these two values will be active. The secondary numeric display (c) will be active indicating the data id number (1-500). The memory locations (a, b, or c) will flash, indicating that you can change the number using the arrow keys \uparrow \downarrow .
2. To enable the data subset number to be changed, press **F1**. The data subset number will now be flashing. To enable the data sub number to be changed, press **F1** again. The data set number will now be flashing. Press **F1** again to change the data id number.
3. Press the down arrow key \downarrow to decrement the enabled number or press the up arrow key \uparrow to increment the enabled number. For storing data, the number can be set to any value, overwriting existing data is allowed. For recalling data, the number can only be set to used values.

Note

If you press the up or down arrow key (\uparrow \downarrow) once, the number increments or decrements by one. If you press and hold the up or down arrow, the numbers increment or decrement quickly by approximately 10 digits per second.

Storing a Measurement

To store a measurement

1. Press **MEMORY** to enter Memory mode.
2. Press **F1** and use the arrow keys (\uparrow \downarrow) to set the data identity.
3. Press **F2** to save the data.
 - If memory is full, FULL will appear on the primary display. Press **F1** to choose another data identity, press **MEMORY** to exit Memory mode.
 - If the memory is not full, the data will be saved, the tester will automatically exit Memory mode and the display will revert back to the previous test mode.

- If the data identity has been previously used, the display will show STO?. Press **F2** again to store the data, press **F1** to choose another data identity, press **MEMORY** to exit Memory mode.

Recalling a Measurement

To recall a measurement

1. Press **MEMORY** to enter the Memory mode.
2. Press **F3** to enter the Recall mode.
3. Use **F1** and the arrow keys (**↶**) to set the data identity. If no data has been saved, all fields will be dashes.
4. Press **F3** to recall the data. The tester display will revert to the Test mode used for the recalled test data, however, the **memory** icon still appears, indicating the tester is still in Memory mode.
5. Press **F3** to toggle between the data id screen and the recalled data screen to check the recalled data id or to select more data to recall.
6. Press **MEMORY** to exit Memory mode at any time.

Clearing Memory

To clear all memory

1. Press **MEMORY** to enter Memory mode.
2. Press **F4**. The primary display will show Clr?. Press **F4** again to clear all memory locations.
3. Press **MEMORY** to exit Memory mode.

Note

All memory locations are cleared when you clear memory. Single memory locations cannot be cleared, but they can be overwritten. See "Storing a Measurement" earlier in this manual.

Uploading Test Results (Model 1653 Only)

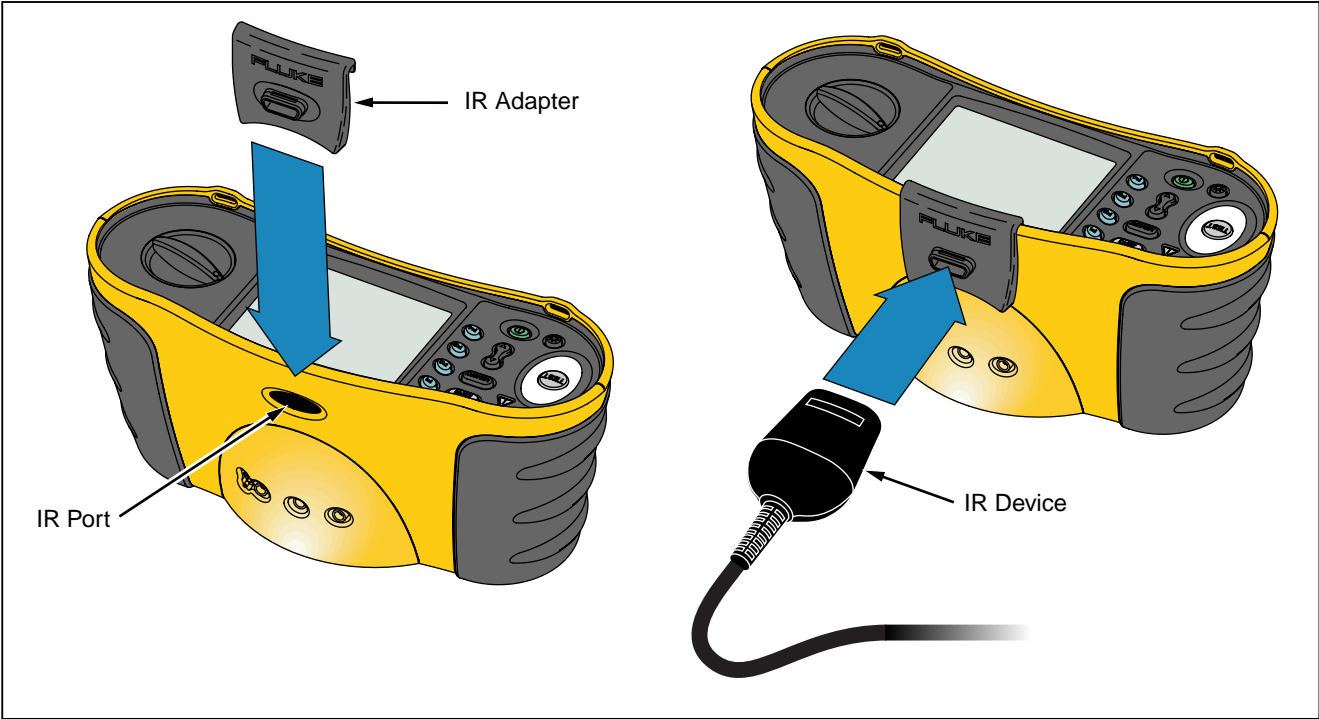

Figure 22. Attaching the IR Adapter

apx031f.eps

To upload test results

1. Connect the IR serial cable to the serial port on the PC.
2. Attach the IR adapter and the device to the tester as shown in Figure 22. Be sure to align the IR adapter to the IR port on the tester.

Note

The IR data port is disabled when test leads are plugged in. Disconnect test leads before attempting to upload test results.

3. Start FlukeView Forms.
4. Select the form template you want to use by opening the File menu and selecting New Blank Form. Highlight the form template in the New Blank Form dialog box and click OK.
5. Press  to turn on the tester.
6. On the FlukeView Forms Meter menu, select Get Meter Data to upload the data to the active form. The Get Meter Data dialog box appears.
7. You can also press the Get Meter Data button to access the dialog box.

8. Data readings are copied directly into the active form. Refer to the *FlukeView Forms Documenting Software Users Manual* for additional information.

Maintaining the Tester***Cleaning***

Periodically wipe the case with a damp cloth and mild detergent. Do not use abrasives or solvents.

Dirt or moisture in the terminals can affect readings.

To clean the terminals

1. Turn the meter off and remove all test leads.
2. Shake out any dirt that may be in the terminals.
3. Soak a new swab with alcohol. Work the swab around each terminal.

Testing and Replacing the Batteries

Battery voltage is continuously monitored by the tester. If the voltage falls below 6.0 V (1.0 V/cell), the low battery icon  appears on the display, indicating that there is minimal battery life left. The low battery icon continues to appear on the display until you replace the batteries.

Warning

To avoid false readings, which could lead to possible electric shock or personal injury, replace the batteries as soon as the battery icon () appears.

Replace the batteries with six AA batteries. Alkaline batteries are supplied with the tester but you can also use 1.2 V NiCd or NiMH batteries. You can also check the battery charge so that you can replace them before they discharge.

Warning

To avoid electrical shock or personal injury, remove the test leads and any input signals before replacing the battery or fuses. To prevent damage or injury, install ONLY specified replacement fuses with the amperage, voltage, and speed ratings shown in the General Specifications section of this manual.

To test the batteries

1. Turn the rotary switch to the V position.
2. Press the  button to initiate the battery test. The Voltage function display clears and is replaced by the measured battery voltage in the secondary display for 2 seconds, the Voltage function display then returns.

To replace the batteries (Refer to Figure 23)

1. Press  to turn the tester off.
2. Remove the test leads from the terminals.
3. Remove the battery door by using a standard-blade screwdriver to turn the battery door screws (3) one-quarter turn counterclockwise.
4. Press the release latch and slide the battery holder out of the tester.
5. Replace the batteries and the battery door.

Note

All stored data will be lost if the batteries are not replaced within approximately one minute (Model 1653 only).

6. Secure the door by turning the screws one-quarter turn clockwise.

Testing and Replacing the Fuse

Warning

To avoid electrical shock or damage to the tester, only use replacement fuses shown in the General Specifications section of this manual.

A fuse test is performed each time you turn on the tester. If leads are plugged in to the L and PE terminals, the fuse test is skipped. If a blown fuse is detected, testing is disabled, FUSE appears on the primary display, and the tester issues a warning beep.

You can also perform a manual check of the fuse.

To manually check the fuse

1. Turn the rotary switch to either R_{ISO} or R_{LO} switch setting.
2. Short the leads and press and hold .
3. If the fuse is bad, FUSE will appear on the display.

To replace the fuse (See Figure 23)

1. Press  to turn the tester off.
2. Remove the test leads from the terminals.
3. Remove the battery door by using a standard-blade screwdriver to turn the battery door screws one-quarter turn counterclockwise.
4. Remove the fuse by gently prying one end loose, then sliding the fuse out of its bracket.
5. Insert the new 1,25 A, 500 V, 50 kA FAST fuse (PN 2040349).
6. Secure the door by turning the screws one-quarter turn clockwise.

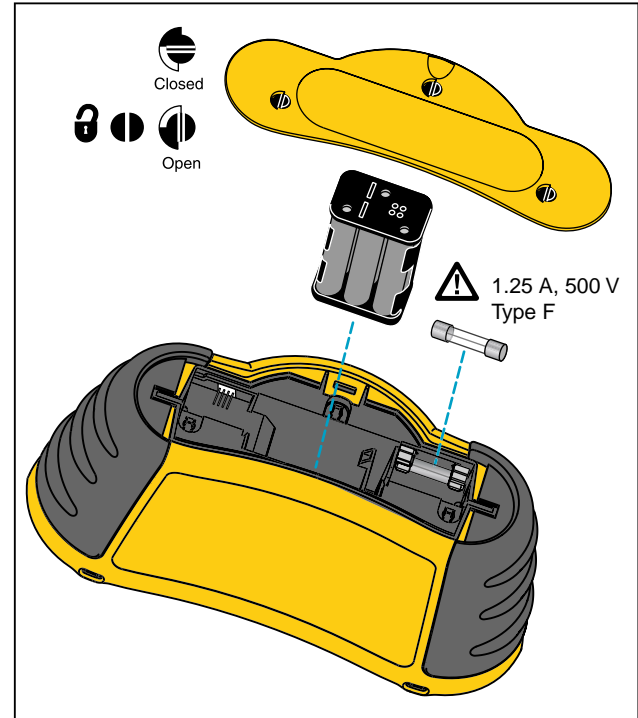

Figure 23. Replacing the Fuse and Batteries

apx028f.eps

Specifications

Features by Model

Measurement Function	1651	1652	1653
Voltage & Frequency	√	√	√
Wiring polarity checker	√	√	√
Insulation Resistance	√	√	√
Continuity & Resistance	√	√	√
Loop & Line Resistance	√	√	√
PFC, PSC (short-circuit current)	√	√	√
RCD switching time	√	√	√
RCD tripping level		√ ramp test	√ ramp test
Automatic RCD test sequence		√	√
Test DC-sensitive RCD's		√	√

Measurement Function	1651	1652	1653
Earth Resistance			√
Phase Sequence Indicator			√
Other Features			
Self-test	√	√	√
Illuminated Display	√	√	√
Memory, Interface			
Memory			√
Computer Interface			√
Time and date (When used with FlukeView software)			√
Software			√
Included Accessories			
Hard case	√	√	√
Remote control probe	√	√	√

General Specifications

Specification	Characteristic
Size	10 cm (L) x 25 cm (W) x 12.5 cm (H)
Weight (with batteries)	1,5 Kg
Battery size, quantity	Type AA, 6 ea.
Battery type	Alkaline supplied. Usable with 1,2 V NiCd or NiMH batteries (not supplied)
Battery life (typical)	200 hours idling
Fuse	1,25 A, 500 V, 50 kA FAST fuse (PN 2040349).
Operating Temperature	-10°C to 40 °C
Storage Temperature	-10 °C to 60 °C indefinitely (to -40 °C for 100 hrs)
Relative Humidity	Noncondensing <10 °C 95% 10 to 30 °C; 75% 30 to 40 °C

Specification	Characteristic
Operating Altitude	0 to 2000 meters
Shock, Vibration	Vibration to Class 3 per Mil-Prf-28800F 1 meter drop test, six sides, oak floor
Sealing	IP-40
EMI Immunity	3 V/meter
EMC	Complies with EN61326
Safety	Complies with UL 3111, ANSI/ISA-S82.01 – 1992 CSA C22.2 No. 1010.1-92 and IEC1010-1 Overvoltage Category III (CAT III), 600 V Measurement Category III is for measurements performed in the building installation. Examples are distribution panels, circuit breakers, wiring and cabling.
Maximum voltage between any terminal and earth ground	500 V
Surge Protection	6 kV peak per IEC 1010.1-92

Electrical Measurement Specifications

The accuracy specification is defined as \pm (% reading +digit counts) at $23\text{ }^{\circ}\text{C} \pm 5\text{ }^{\circ}\text{C}$, $\geq 80\%$ RH. Between $-10\text{ }^{\circ}\text{C}$ and $18\text{ }^{\circ}\text{C}$ and between $28\text{ }^{\circ}\text{C}$ and $40\text{ }^{\circ}\text{C}$, accuracy specifications may degrade by $0,1 \times$ (accuracy specification) per $^{\circ}\text{C}$.

AC Voltage Measurement (V)

Range	Resolution	Accuracy 50Hz - 60Hz	Input Impedance	Overload Protection
500 V	0,1 V	0,8% + 3	3,3 M Ω	660 V rms

Continuity Testing (R_{LO})

Range (Autoranging)	Resolution	Open Circuit Voltage	Accuracy
20 Ω	0,01 Ω		\pm (1,5%+3 digits)
200 Ω	0,1 Ω	> 4 V	\pm (1,5%+3 digits)
2000 Ω	1 Ω		\pm (1,5%+3 digits)

The test current is 200 mA for resistances of 2 Ω or less. The number of possible continuity tests with a fresh set of batteries is 3000.

Test Probe Zeroing

- Press the **ZERO** button to zero the test probe.
- Can subtract up to 2 Ω of lead resistance.
- Error message for >2 Ω .

Live Circuit Detection	Inhibits test if terminal voltage > 10 V ac detected prior to initiation of test.
-------------------------------	---

Insulation Resistance Measurement (R_{ISO})

Test Voltages			Accuracy of Test Voltage (at rated test current)
Model 1651	Model 1652	Model 1653	
500-1000 V	250-500-1000 V	50-100-250-500-1000 V	+10%, -0%

Test Voltage	Insulation Resistance Range	Resolution	Test Current	Accuracy
50 V	10 k Ω to 50 M Ω	0,01 M Ω	1 mA @ 50 k Ω	\pm (3%+3 digits)
100 V	100 k Ω to 20 M Ω	0,01 M Ω	1 mA @ 100 k Ω	\pm (3%+3 digits)
	20 M Ω to 100 M Ω	0,1 M Ω	1 mA @ 100 k Ω	\pm (3%+3 digits)
250 V	100 k Ω to 200 M Ω	0,1 M Ω	1 mA @ 250 k Ω	\pm (1,5%+3 digits)
500 V	100 k Ω to 200 M Ω	0,1 M Ω	1 mA @ 500 k Ω	\pm (1,5%+3 digits)
	200 M Ω to 500 M Ω	1 M Ω	1 mA @ 500 k Ω	\pm 10%
1000 V	100 k Ω to 200 M Ω	0,1 M Ω	1 mA @ 1 M Ω	\pm (1,5%+3 digits)
	200 M Ω to 1000 M Ω	1 M Ω	1 mA @ 1 M Ω	\pm 10%

The number of possible insulation tests with a fresh set of batteries is 2000.

Auto Discharge	Discharge time constant < 0.5 second for C = 1 uF or less.
Live Circuit Detection	Inhibits test if terminal voltage > 30 V prior to initiation of test.
Maximum Capacitive Load:	Operable with up the 5 uF load.

Loop and Line Impedance (Z_l)

Measuring Range	100 - 500 V ac (50/60 Hz)
Input Connection (soft key selection)	Loop Impedance: phase to earth
	Line impedance: phase to neutral
Limit on Consecutive Tests	Automatic shutdown when internal components are too hot. There is also a thermal shutdown for RCD tests.

Range	Resolution	Accuracy*
20 Ω	0,01 Ω	\pm (3% + 10 digits)
200 Ω	0,1 Ω	\pm (3% + 10 digits)
2000 Ω	1 Ω	\pm (3% + 10 digits)
*Valid for resistance of neutral circuit <20 Ω		

PFC, PSC Test

Computation	PFC or PSC determined by dividing measured mains voltage by measured loop (L-PE) resistance or line (L-N) resistance.	
Range	0 to 10 kA	
Resolution and Units	Resolution	Units
	$I_k < 1000 \text{ A}$	1 A
	$I_k > 1000 \text{ A}$	0.1 kA
Accuracy	Determined by accuracy of loop resistance and mains voltage measurements.	

RCD Testing

RCD Types Tested

RCD Type*		Model 1651	Model 1652	Model 1653
¹ AC	² G	√	√	√
AC	³ S	√	√	√
⁴ A	G		√	√
A	S		√	√
¹ AC – Responds to AC ² G – General, no delay ³ S – Time delay ⁴ A – Responds to pulsed signal *RCD test inhibited for V > 280 V ac				

Test Signals

RCD Type	Test Signal Description
AC	The waveform is a sinewave starting at zero crossing, polarity determined by phase selection (0° phase starts with low to high zero crossing, 180° phase starts with high to low zero crossing). The magnitude of the test current is $I_{\Delta n} \times \text{Multiplier}$ for all tests.
A	The waveform is a half wave rectified sinewave starting at zero, polarity determined by phase selection (0° phase starts with low to high zero crossing, 180° phase starts with high to low zero crossing). The magnitude of the test current is $2.0 \times I_{\Delta n} \times \text{Multiplier}$ for all tests for $I_{\Delta n} = 0.01A$. The magnitude of the test current is $1.4 \times I_{\Delta n} \times \text{Multiplier}$ for all tests for all other $I_{\Delta n}$ ratings.

Tripping Speed Test (ΔT)

Model 1651

Current Settings	Multiplier	Current Accuracy	*RCD Type	Maximum Test Time
10–30–100–300-500-1000 mA	x 1	+10% -0%	G	310 ms
10–30–100–300-500-1000 mA	x 1	+10% -0%	S	510 ms
*G – General, no delay *S – Time delay				

Tripping Speed Test (ΔT)

Models 1652 and 1653

Current Settings	Multiplier	Current Accuracy
10–30–100–300-500-1000 mA	x ½	+0% -10% of test current
10–30–100–300-500-1000 mA	x 1	+10% -0%
10-30 mA	x 5	±10%

Current Multiplier	*RCD Type	Measurement Range		Trip Time Accuracy
		Europe	UK	
x ½	G	310 ms	2000 ms	±(1% Reading + 1 digit)
x ½	S	510 ms	2000 ms	±(1% Reading + 1 digit)
x 1	G	310 ms	310 ms	±(1% Reading + 1 digit)
x 1	S	510 ms	510 ms	±(1% Reading + 1 digit)
x 5	G	50 ms	50 ms	±(1% Reading + 1 digit)
x 5	S	160 ms	160 ms	±(1% Reading + 1 digit)

*G – General, no delay
*S – Time delay

Tripping Current Measurement/Ramp Test ($I_{\Delta N}$)

Models 1652 and 1653

Current Range	Step Size	Dwell Time		Measurement Accuracy
		Type G	Type S	
50% to 110% of RCD's rated current	10% of $I_{\Delta N}$	300 ms/step	500 ms/step	$\pm 5\%$

Earth Resistance Test (R_E)

Model 1653 Only

Range	Resolution	Accuracy
200 Ω	0,1 Ω	$\pm (2\% + 5 \text{ digits})$
2000 Ω	1 Ω	$\pm (3,5\% + 10 \text{ digits})$

Frequency	Compliance Voltage
128 Hz	+ 25 V



Live Circuit Detection	Inhibits test if terminal voltage > 10 V ac is detected prior to start of test.
-------------------------------	---

Phase Sequence Indication

Model 1653 Only

Icon	 icon Phase Sequence indicator is active.
Display of Phase Sequence	Displays "1-2-3" in digital display field for correct sequence. Displays "3-2-1" for incorrect phase. Dashes in place of a number indicate a valid determination could not be made.

Mains Wiring Test

Icons (, , ) indicate if L-PE or L-N terminals are reversed. Instrument operation is inhibited and an error code is generated if the input voltage is not between 100 V and 500 V.